



Owner's Manual

Original Instructions

Wired Controller XK117

Thank you for choosing commercial air conditioners. Please read this Owner's Manual carefully before operation and retain it for future reference.

If you have lost the Owner's Manual, please contact the local agent or visit www.gree.com or send an email to global@gree.com.cn for the electronic version.

GREE ELECTRIC APPLIANCES, INC. OF ZHUHAI



To Users

Thank you for selecting Gree's product. Please read this instruction manual carefully before installing and using the product, so as to master and correctly use the product. In order to guide you to correctly install and use our product and achieve expected operating effect, we hereby instruct as below:

- (1) This appliance is not intended for use by persons (including children) with reduced physical, sensory or mental capabilities, or lack of experience and knowledge, unless they have been given supervision or instruction concerning use of the appliance by a person responsible for their safety. Children should be supervised to ensure that they do not play with the appliance.
- (2) This instruction manual is a universal manual, some functions are only applicable to particular product. All the illustrations and information in the instruction manual are only for reference, and control interface should be subject to actual operation.
- (3) In order to make the product better, we will continuously conduct improvement and innovation. We have the right to make necessary revision to the product from time to time due to the reason of sales or production, and reserve the right to revise the contents without further notice.
- (4) For personal injury or property loss and damage caused by improper operation such as improper installation and debugging, unnecessary maintenance, violation of related national laws and rules and industrial standard, and violation of this instruction manual, etc., we will bear no liability.
- (5) The final right to interpret for this instruction manual belongs to Gree Electric Appliances, Inc. of Zhuhai.

Contents

1	Installation	1
1.1	Dimension and Component of Wired Controller	1
1.2	Installing Position and Requirements of Wired Controller	2
1.3	Installation of Wired Controller	3
1.4	Disassembly of Wired Controller	5
2	Introduction to Display	5
2.1	Outline of Wired Controller	5
2.2	Liquid Crystal Display of Wired Controller	6
2.3	Instruction for Liquid Crystal Display of Wired Controller	6
3	Instruction for Operation	8
3.1	Silkscreen of Buttons	8
3.2	ON/OFF Setting	8
3.3	Mode Setting	10
3.4	Setting of Temperature	10
3.5	Setting of Fan Speed	12
3.6	Setting of Up & Down Swing Function	12
3.7	Setting of Timer Function	13
3.8	Setting of Functional Buttons	14
3.9	Setting of Other Functions	17
3.9.1	Setting of Energy-saving Function	17
3.9.2	Setting of Low-temperature Dry Function	17
3.9.3	Setting of Child-lock Function	18

3.9.4 Setting of Memory Function	18
3.9.5 Switch between Fahrenheit and Degree Celsius	18
3.9.6 Inquiry of Ambient Temperature	18
4 Display of Errors	19

1 Installation

1.1 Dimension and Component of Wired Controller

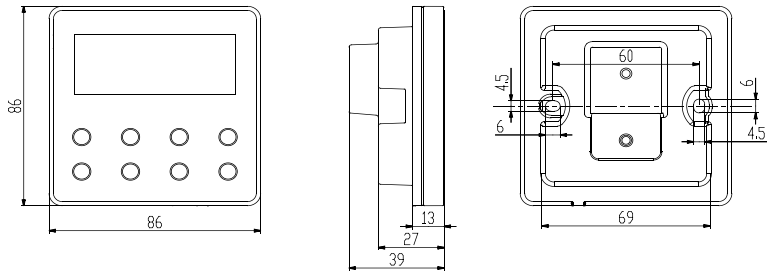

Figure 1-1 Dimension of Wired Controller (Unit : mm)

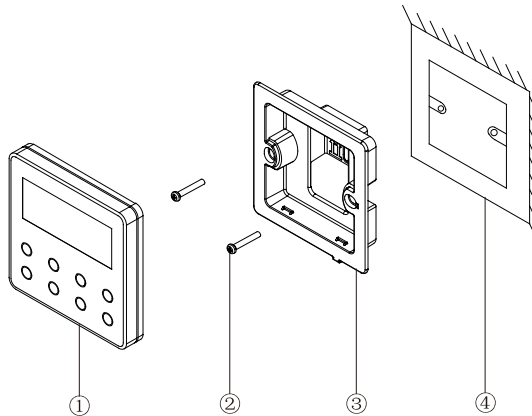

Figure 1-2 Components of Wired Controller

Table 1.1.1 Introduction of Components

No.	①	②	③	④
Name	wired controller	screw M4×25	installing box of wired controller	junction box for installing inside the wall
Quantity	1	2	1	1(prepared by user)

1.2 Installing Position and Requirements of Wired Controller

- (1) Please do not install the wired controller in the position where is wet or is likely to be splashed with water;
- (2) Please do not install the wired controller near high-temperature objects or under direct sunlight;
- (3) Please do not install the wired controller in the position where facing the window, so as to avoid interference of neighbor's remote controller with the same model and cause malfunction;
- (4) Before installation, please cut off the power supply of strong current wire inside the wall, it is not allowed to install under electrified status;
- (5) In order to avoid malfunction due to electromagnetic interference and other causes, please pay attention to the following notices:
 - 1) Make sure that the interface of communication wire is correct, otherwise the communication cannot work;
 - 2) Signal wire of wired controller should be separated from the power cord and indoor and outdoor connecting wire, the shortest distance should be over 20cm, otherwise the communication cannot work normally;
 - 3) If the unit is installed in the position where is likely to be impacted by electromagnetic interface, signal wire of wired controller should be made of STP (shielded twisted pair).

- (6) The wired controller should only be installed indoors, and its working temperature range is 0°C ~ 50°C.

1.3 Installation of Wired Controller

First to select the right signal wire of wired controller: 2-core signal wire (wire diameter $\geq 0.75\text{mm}$, length $< 30\text{m}$, recommendable length is 8m).

For installation steps of wired controller please refer to the following sketch map, brief instructions are as below:

- (1) Before installation, please cut off the power supply of indoor unit, live working during installation is not allowed;
- (2) Pull out the 2-core STP inside the wall from the installing hole, thread the wire through the connecting hole in the back of soleplate of wired controller;
- (3) Stick the soleplate of wired controller on the wall, use screw M4×25 to fix the soleplate onto the installing hole of wall;
- (4) Connect the 2-core STP with the two wiring terminals in the back of wired controller respectively, and screw up the screw; no polarity for these two wiring terminals, but note that it should not be connected to strong current;

(5) Buckle the panel of wired controller with the soleplate, then the installation is finished.

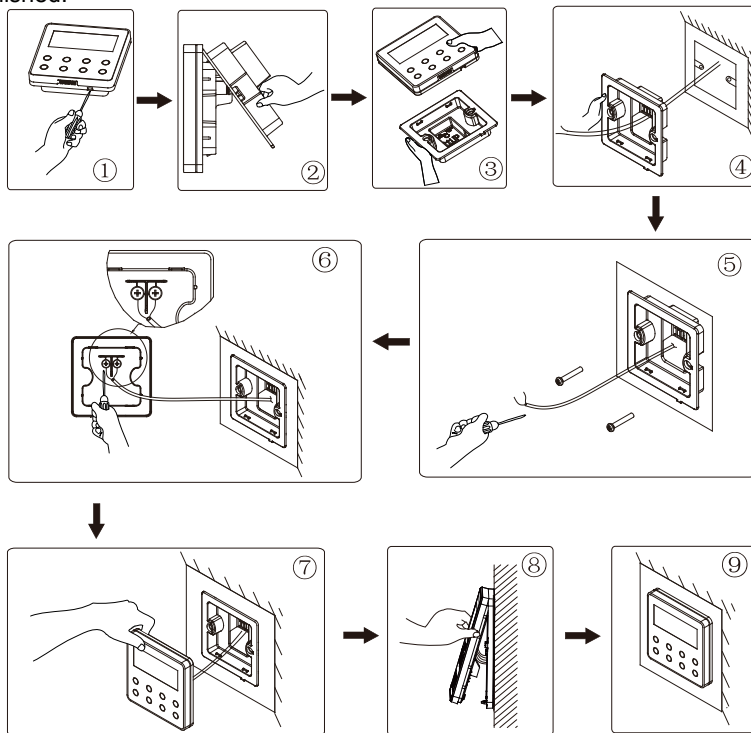

Figure 1-3 Sketch Map for Installation of Wired Controller

1.4 Disassembly of Wired Controller

Disassembly for wired controller is as below:

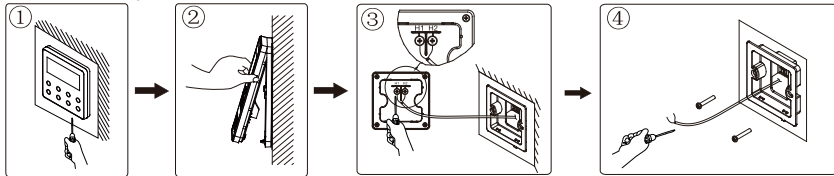

Figure 1-4 Sketch Map for Disassembly of Wired Controller

2 Introduction to Display

2.1 Outline of Wired Controller

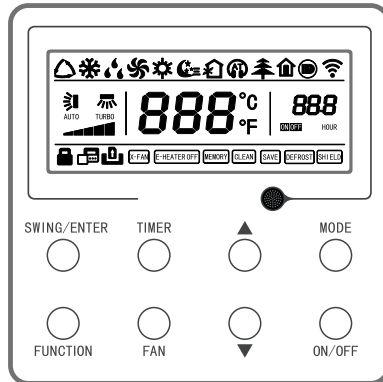

Figure 2-1 Outline of Wired Controller

2.2 Liquid Crystal Display of Wired Controller

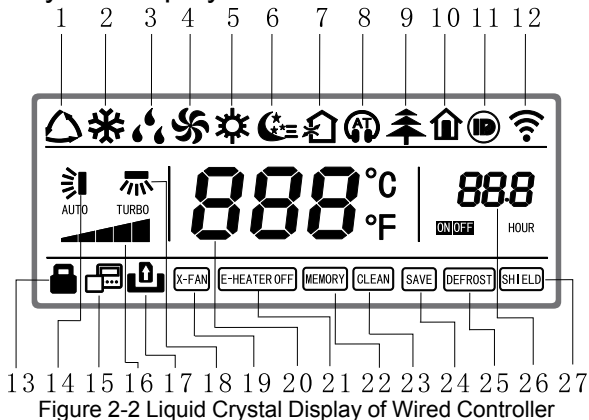

Figure 2-2 Liquid Crystal Display of Wired Controller

2.3 Instruction for Liquid Crystal Display of Wired Controller

Table 2.3.1 Instruction for Liquid Crystal Display of Wired Controller

No.	Display	Instruction of Display
1	Auto	Automatic mode (under auto mode, the indoor unit will select its operating mode according to the variation of room temperature)
2	Cool	Cooling mode
3	Dry	Dry mode
4	Fan	Fan mode
5	Heat	Heating mode
6	Sleep	Display when sleep function is set (only display sleep mode II)

No.	Display	Instruction of Display
7	Exchange	Display when air exchange function is set
8	Silent	Display when silent function is set (only display silent, no AT)
9	Health	Display when health function is set
10	Absent	Display when absent function is set
11	I-DEMAND	Display when I-DEMAND function is set
12	WIFI	WIFI function icon (reserve this function, no this function for wired controller)
13	Child-lock	Child-lock status, display when child-lock function is set
14	Up & down swing	Display when up and down swing function is set
15	Slave wired controller	Icon of slave wired controller, it will display when slave wired controller is set
16	Fan speed	The fan speed set currently (including auto, low, medium and low, medium, medium and high, high, and turbo)
17	No card	No card in gate control system
18	Left & right swing	Display when left and right swing function is set
19	X-fan	Display when dry function is set
20	Temperature	It will display the setting temperature
21	E-heater	On/off switch of auxiliary heating
22	Memory	Memory status (After power failure and re-energizing the unit, it will resume to ON/OFF status of unit before the power failure)

No.	Display	Instruction of Display
23	Clean	Filter washing reminder
24	Save	Display when energy-saving function is set
25	Defrost	Defrosting status
26	Timer	Display when timer status is set
27	Shield	Shielding status

3 Instruction for Operation

3.1 Silkscreen of Buttons

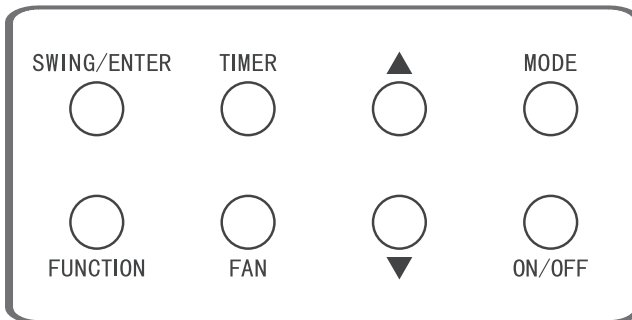

Figure 3-1 Silkscreen of Buttons

3.2 ON/OFF Setting

Press “ON/OFF” button to turn on the air conditioner, then the wired controller will display the setting temperature, fan speed, mode, etc. Press “ON/OFF” again to stop the operation of air conditioner, then the wired controller only displays the setting temperature. ON and OFF status of unit will display as below.

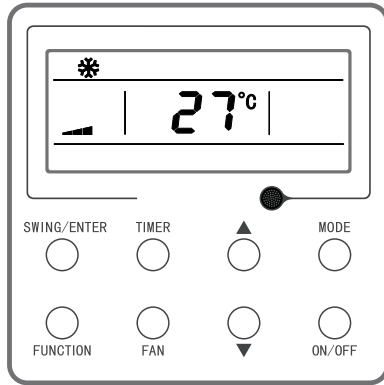

Figure 3-2 ON Status

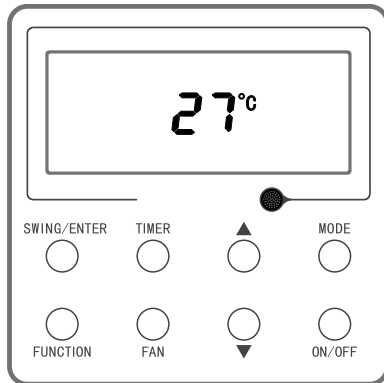

Figure 3-3 OFF Status

3.3 Mode Setting

Under power-on status, each time press the “MODE” button, the mode will switch circularly according to the following order, as shown in the figure.

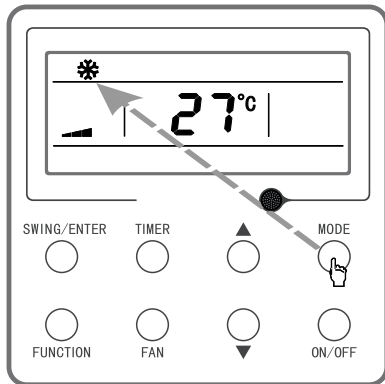

Figure 3-4 Mode Setting

Note:

Under auto mode, if the unit conducts auto cooling, then “△” and “❄️” turn on; if the unit conducts auto heating, then “△” and “☀️” turn on.

3.4 Setting of Temperature

Under power-on status, press “▲” or “▼” button, the setting temperature will increase or decrease at the unit of 1°C; when press and hold the button, it will increase or decrease at the unit of 1°C in every 0.3 second. Operation is as below:

Temperature setting range under cooling, dry, fan and heating mode is: 16°C ~ 30°C. The setting temperature cannot be adjusted under auto mode.

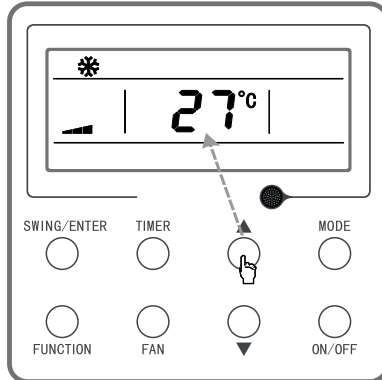

Figure 3-5 Setting of Temperature

3.5 Setting of Fan Speed

Under power-on status, press “FAN” button, the fan speed will switch circularly according to the following order, as shown below.

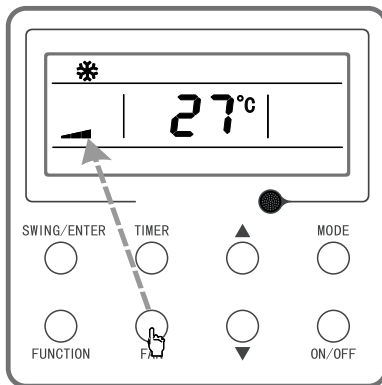
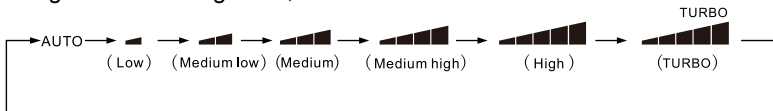

Figure 3-6 Setting of Fan Speed

Note:

- (1) Under dry mode, the fan speed will automatically set as low speed, and the fan speed cannot be adjusted.
- (2) Under fan and auto mode, turbo speed cannot be set.

3.6 Setting of Up & Down Swing Function

There are two ways for up and down swing mode: simple swing and fixed swing. Under power-off status, press “SWING/ENTER” button and “▲” button

simultaneously for 5 seconds, the up & down swing icon will flash, then switch for simple swing and fixed swing is done.

When it is set to be simple swing, under power-on status, press “SWING/ENTER” button, the mode is activated, press the button again the mode is turned off.

When it is set to be fixed swing, press “SWING/ENTER” button, the unit will circularly switch the swing mode according to the order shown below:

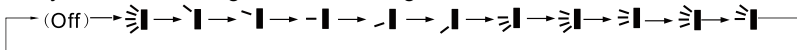

Figure 3-7 Order for Up & Down Fixed Swing

Note:

Whether the fixed swing mode is successfully set depends on whether the unit model can support such function.

3.7 Setting of Timer Function

Under ON/OFF status, press “TIMER” button can set ON/OFF time of unit;

Timer-on setting: under power-off status and timer function has not been set, press “TIMER” button, the liquid crystal screen will display “xx.x hour”, and “ON” and “hour” icons flash simultaneously, then press “▲” or “▼” button to adjust the power-on time. Press “TIMER” button, the setting is done. If before pressing “TIMER” button to finish the setting, press “MODE” button can switch to timer setting status, liquid crystal screen will display “xx.x hour”, and “OFF” and “hour” icons flash simultaneously, then press “▲” or “▼” button to adjust the power-off time, and press “TIMER” button again to finish the setting, the timer area will display “xx.x hour ON/OFF”, “xx.x hour” is the time for turning on the unit in setting time, and timer-off time is not displayed.

Timer-off setting: under power-on status and timer function has not been set, press “TIMER” button, the liquid crystal screen will display “xx.x hour”, and “OFF” and “hour” icons flash simultaneously, then press “▲” or “▼” button to adjust the

power-off time. Press “TIMER” button, the setting is done. If before pressing “TIMER” button to finish the setting, press “MODE” button can switch to timer setting status, liquid crystal screen will display “xx.x hour”, and “ON” and “hour” icons flash simultaneously, then press “▲” or “▼” button to adjust the power-on time, and press “TIMER” button again to finish the setting, the timer area will display “xx.x hour ON/OFF”, “xx.x hour” is the time for turning off the unit in setting time, and timer-on time is not displayed.

Cancel timer: after setting the timer function, press “TIMER” button, the liquid crystal screen will not display “xx.x hour” anymore, the timer function is canceled.

Timer area: 0.5~24 hours. Each time press “▲” or “▼” button, the setting time will increase/decrease 0.5 hour, press and hold the buttons the unit will automatically increase/decrease 0.5 hour in every 0.3 second.

Note:

Under power-on status, the timer-on time is counted from the time when the unit is turned off; under power-off status, the timer-off time is counted from the time when the unit is turned on.

3.8 Setting of Functional Buttons

Under power-on status, press “FUNCTION” button can select to set sleep (can be set under cooling, dry, heating modes), air exchange, silent (can be set under auto, cooling, heating modes), health, absent (can be set under heating mode), I-Demand (can be set under cooling mode), left & right swing, turbo fan (can be set under cooling and heating modes), X-fan (can be set under cooling and dry mode), auxiliary heating (can be set under heating mode), and washing remind function. The selected functional icon will flash, then press “SWING/ENTER” button can activate or cancel such function. Before setting, if the function has not been activated, press “SWING/ENTER” can turn on such function; if the function is activated before setting, press “SWING/ENTER” button can turn off such function. When the

function is activated, the corresponding icon will turn bright. After finishing setting one function, it will jump to the next functional setting.

Specific instructions for setting of the following functions:

- (1) When setting air exchange function, there are a total 10 types of air exchange modes from 1 to 10, the temperature area will display the current mode, first press “▲” or “▼” button to select the mode, then press “SWING/ENTER” button to confirm. For details of air exchange mode are as below:
 - 1——the unit runs for 60 minutes, fresh air valve opens for 6 minutes;
 - 2——the unit runs for 60 minutes, fresh air valve opens for 12 minutes;
 - 3——the unit runs for 60 minutes, fresh air valve opens for 18 minutes;
 - 4——the unit runs for 60 minutes, fresh air valve opens for 24 minutes;
 - 5——the unit runs for 60 minutes, fresh air valve opens for 30 minutes;
 - 6——the unit runs for 60 minutes, fresh air valve opens for 36 minutes;
 - 7——the unit runs for 60 minutes, fresh air valve opens for 42 minutes;
 - 8——the unit runs for 60 minutes, fresh air valve opens for 48 minutes;
 - 9——the unit runs for 60 minutes, fresh air valve opens for 54 minutes;
 - 10——Both the unit and fresh air valve are turned on.
- (2) When setting auxiliary heating function, press “▲” and “▼” buttons can turn on or turn off the auxiliary heating mode, when “E-HEATER” flashes, it means the old auxiliary heating mode is turned on, when “” flashes, it means the new national standard auxiliary heating mode is turned on, when “E-HEATER OFF” flashes, it means the auxiliary heating is prohibited. After selecting the mode, press “SWING/ENTER” button to confirm the setting. When new national standard auxiliary heating mode is set, the character of auxiliary heating will not display; when the old auxiliary heating mode is set, the character of auxiliary heating will display. When the auxiliary heating mode is turned off, it will display “E-HEATER OFF”.

(3) When setting washing remind function, the timer area will display 2-bit number that means the pollution level, then press “▲” and “▼” buttons to select, and press “SWING/ENTER” button to confirm the setting. Conversion relation between the displayed pollution level and accumulative operating time are as the following list. After setting, when it reaches the washing time, “CLEAN” icon will flash and remind, if you press “▲” and “▼” buttons to adjust the level, and press “SWING/ENTER” button, then the accumulative time for filter washing remind will not be reset; if the time after adjustment is larger than the current accumulative time, then “CLEAN” icon will stop flashing; if the time after adjustment is less than the current accumulative time, then “CLEAN” icon will continue to flash. The only method for cancelling the remind function is to press “FUNCTION” button to switch to “CLEAN” icon, and set the timer area to be “00”, and then press “SWING/ENTER” button, then the accumulative time of filter washing remind is reset.

Table 3.8.1 Pollution Level Parameter List

Pollution Level	Accumulative operating time (hour)	Pollution Level	Accumulative operating time (hour)	Pollution Level	Accumulative operating time (hour)
10	5500	20	1400	30	100
11	6000	21	1800	31	200
12	6500	22	2200	32	300
13	7000	23	2600	33	400
14	7500	24	3000	34	500
15	8000	25	3400	35	600
16	8500	26	3800	36	700
17	9000	27	4200	37	800

Pollution Level	Accumulative operating time (hour)	Pollution Level	Accumulative operating time (hour)	Pollution Level	Accumulative operating time (hour)
18	9500	28	4600	38	900
19	10000	29	5000	39	1000

- (4) When absent function is set, the setting temperature will display 8°C, the setting fan notch displays auto and cannot be adjusted.
- (5) When I-Demand function is set, the temperature area will display “SE”, the setting fan notch displays auto and cannot be adjusted.

3.9 Setting of Other Functions

3.9.1 Setting of Energy-saving Function

Under power-off status, press “TIMER” and “▲” buttons simultaneously for 5 seconds to enter into energy-saving setting, then “SAVE” character or icon and cooling mode icon are displayed, the “SAVE” character or icon flashes, the temperature area displays the upper limit and lower limit temperature, press “▲” or “▼” button can set the limit temperature(setting range is 16–30). Press “MODE” button can switch cooling or heating mode. For cooling only unit, it can only set the lower limit temperature of cooling under energy-saving mode. During the setting, press “SWING/ENTER” button at any time can save the setting temperature and energy-saving status of different modes, and then start up the energy-saving function.

After the energy-saving function is activated, under power-off status, press “TIMER” and “▲” buttons simultaneously for 5 seconds again, the function is canceled.

3.9.2 Setting of Low-temperature Dry Function

Under dry mode, when the setting temperature is 16°C, press “▼” button for twice, the setting temperature becomes 12°C, then the unit enters into low-temperature dry function.

When low-temperature dry function is turned on, directly press “▲” button or switch the mode can quit the function.

3.9.3 Setting of Child-lock Function

Without error, under ON or OFF status of unit, press “▲” and “▼” buttons simultaneously for 5 seconds can enter into child-lock function, the liquid crystal screen will display “”; press “▲” and “▼” buttons simultaneously again for 5 seconds can quit the child-lock function.

Under child-lock status, no response for pressing any buttons. The unit will memorize the child-lock status after power failure and re-energizing the unit.

3.9.4 Setting of Memory Function

Under power-off status, press “MODE” and “▲” button simultaneously for 5 seconds can turn on or turn off memory function. When memory function is set, “MEMORY” displays.

If memory function has not been set, when the unit is re-energized after power failure, the unit is power-off status. If the memory function is set in wired controller, when the wired controller is re-energized after power failure, it will resume to the operating status before power failure.

3.9.5 Switch between Fahrenheit and Degree Celsius

Under power-off status, press “MODE” and “▼” buttons simultaneously for 5 seconds, display board will switch between degree Celsius and Fahrenheit.

3.9.6 Inquiry of Ambient Temperature

Under power-off or power-on status, press and hold “SWING/ENTER” button for 5 seconds to enter into ambient temperature inquiry interface, then timer area displays the ambient temperature type 01 or 02, and ambient temperature area displays the corresponding ambient temperature of corresponding type. In which, 01 refers to outdoor ambient temperature, 02 refers to indoor ambient temperature. Press “MODE” button can switch between type 01 and 02. Press

buttons other than “MODE” or when the unit receives remote control signal, it will quit the inquiry status. If there is no any operation for 20 seconds, it will quit automatically.

Note:

When the outdoor ambient temperature sensor detects the same temperature for 12 hours, it will shield the display of outdoor ambient temperature sensor.

4 Display of Errors

When error occurs in the system, temperature display area in liquid crystal panel will display error code, when multiple errors occur simultaneously, it will circularly display error code. If the wired controller has been connected to multiple systems, when error occurs in a certain system, the first bit of number in temperature area will display the system number (it will not display system number when there is only one system).

When error occurs, please turn off the unit and seek for professional personnel to maintain.

The following figure refers to the high-pressure protection under power-on status.

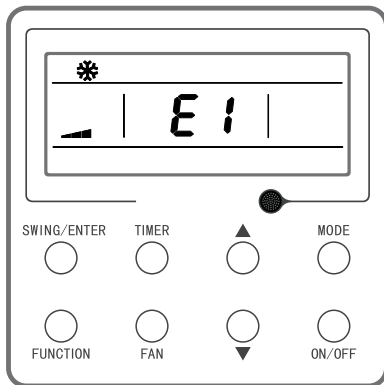

Figure 4-1 High-pressure Protection

Table 4.1 Error Code List

Error Code	Error
E1	Compressor high-pressure protection
E2	Indoor anti-freeze protection
E3	Compressor low-pressure protection, refrigerant lack protection, refrigerant collection mode
E4	Compressor air discharge high-temperature protection
E6	Communication error
E8	Indoor fan error
E9	Water-full protection

Error Code	Error
F0	Indoor ambient temperature sensor error
F1	Evaporator temperature sensor error
F2	Condenser temperature sensor error
F3	Outdoor ambient temperature sensor error
F4	Discharge temperature sensor error
F5	Wired controller temperature sensor error
C5	IDU jumper cap error
EE	IDU or ODU memory chip error
PF	Electric box sensor error
H3	Compressor overload protection
H4	Overload
H5	IPM protection
H6	DC fan error
H7	Driver out-of-step protection
HC	pfc protection
Lc	Startup failure
Ld	Compressor phase-sequence protection
LF	Power protection
LP	IDU and ODU unmatched
U7	4-way valve switch-over error
P0	Driver reset protection

Wired Controller XK117

Error Code	Error
P5	Over-current protection
P6	Master control and driver communication error
P7	Driver module sensor error
P8	Driver module high temperature protection
P9	Zero-crossing protection
PA	AC current protection
Pc	Driver current error
Pd	Sensor connection protection
PE	Temperature drift protection
PL	Bus low-voltage protection
PH	Bus high-voltage protection
PU	Charging loop error
PP	Input voltage error
ee	Driver memory chip error
C4	ODU jumper cap error
dJ	Phase-loss and anti-phase protection
oE	ODU error, for specific error please see the status of ODU indicator



GREE ELECTRIC APPLIANCES, INC. OF ZHUHAI

Add: West Jinji Rd, Qianshan, Zhuhai, Guangdong, China, 519070

Tel: (+86-756) 8522218

Fax: (+86-756) 8669426

E-mail: gree@gree.com.cn www.gree.com



600005000871